



# CROSSTOWN Metal Industries ... PRESENTS

**Even More Exciting Entertainment Industry**



**Supply Offerings For:  
Film/TV Productions**

**Plus Stage/Theatre  
and Concerts/Events**



- *Budget Saving* •
- *Fast Turnaround* •



# Crosstown's Film/TV Supplier History

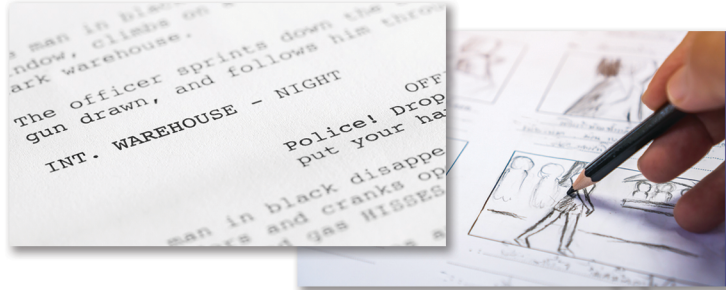

## 2022: Crosstown Expands Its Film/TV Offerings

For years, Crosstown has supplied the Vancouver entertainment industry with exceptional metal scenic looks - *industrial, practical, architectural, or fictionally futuristic*. Now, it's adding much more for **INT/EXT set flat fronts/fixtures, art dec, props, and on set FX.**

## Crosstown Industries No Longer Just For Metal

Crosstown has installed a **bleeding-edge large format 2.5D printer** that reproduces incredibly high-resolution graphics/photos on virtually any material up to 8 x 10 feet in size. These printings are also **distinctly textured**, that when lit, bring a new realism to any facade. Also, a **massive 3D cutter station** is now in the extensive new additional shop space forging **multidimensional set dec and props.**

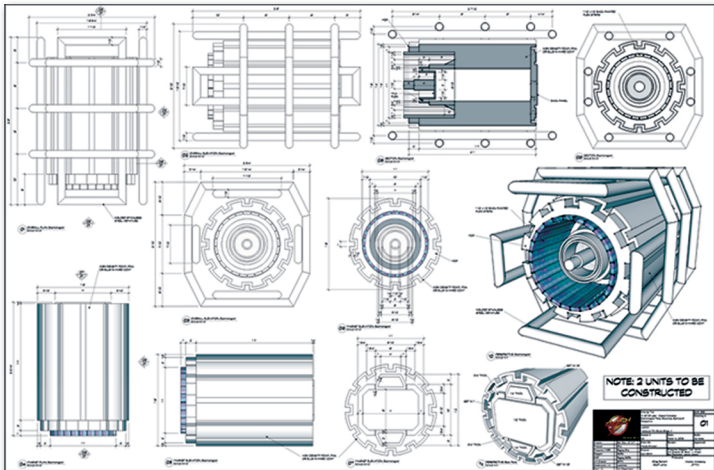
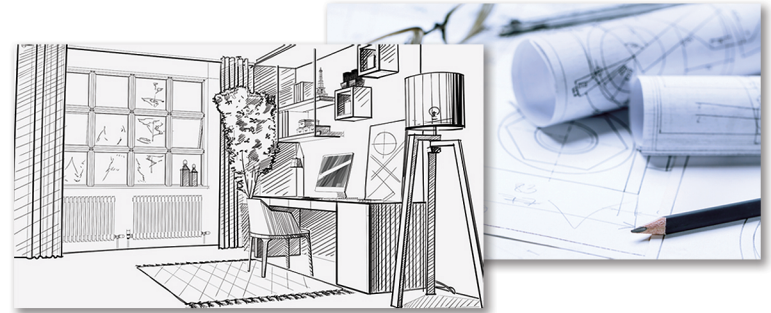

A Crosstown engineering team's pre-fabrication draft of custom metal works for **ViacomCBS'** series, **The Flash**.

## Crosstown Conquers Challenges

*Creative design requires technical precision.* Daily, veteran project managers, backed by SolidWorks and AutoCAD specialists, expertly guide a 75-strong workforce from their North Surrey operations.

Collaborating smoothly with industrial architects has been no different than assisting **Production Designers and Art Directors.** Crosstown easily translates even the most complicated visions into reality - *satisfying any unique needs or schedule.*



Some client credits:\*



\*All trademarks, logos, and images are the property of their respective/rightful owners.

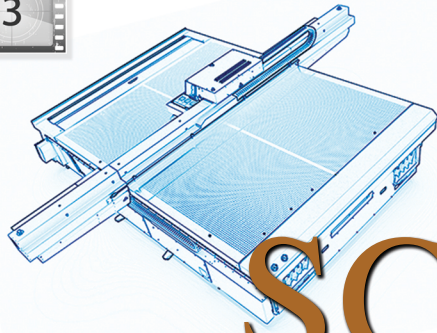

# Digitally Printed SCENERY FLATS

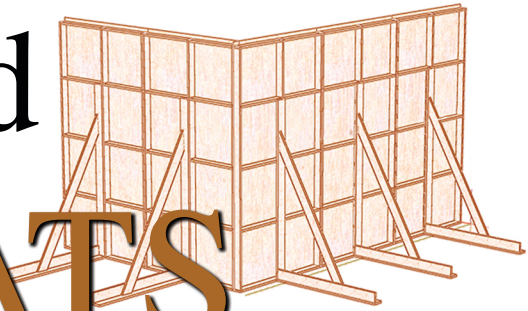

**Up to 8 x 10 feet • INT/EXT's • Textured**

**On virtually any material - soft, bendable, or hard**



From **muslin**/canvas/fabrics to **plywood**, acrylics, **glass**, or substrates such as **Alucobond**, your flat fronts can be **opaque**, **translucent** and even art on fully **transparent**. There's also a **roller** option for large format **wall paper** or **poster** needs.

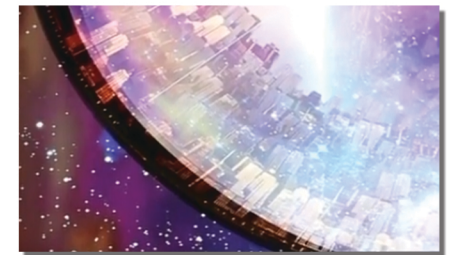

*NOTE: All photos are of actual reproductions from this 2.5D printer.*



# Textures - Flats That Aren't ... Flat

## Ah, Go Ahead - Make Your D.P. Smile

Imagine having soundstage **camera positions right up close** and not restricted to twenty feet away at a dull 90 degrees, along with lazy lighting resembling an aisle at a big-box store. **Your Gaffer is actually having fun**, using mostly practicals and windows, **creating a realism rarely seen**. Picture an excited Director able to block **actors within inches** of either **INT studio** or **EXT location flats/facades**.

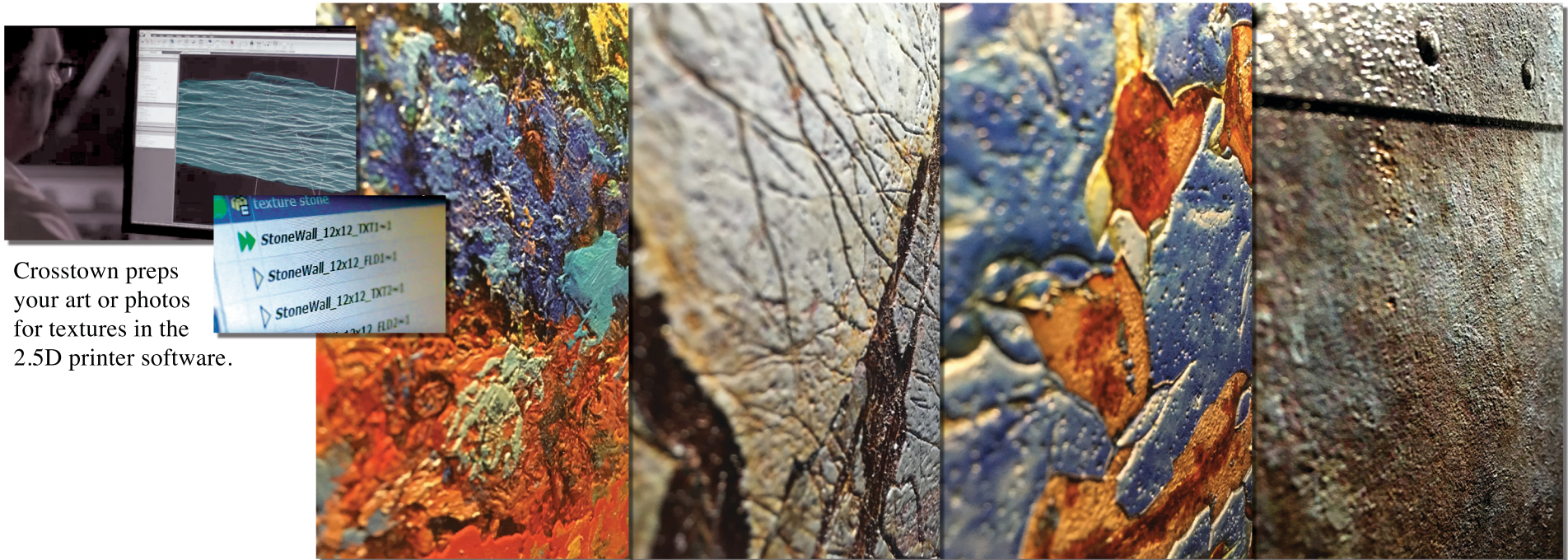

Crosstown preps your art or photos for textures in the 2.5D printer software.

A **critical script location** is still, for months, closed to any productions. Yet, they'll allow a skeleton photo crew in for a half day. Simply furnish Crosstown with film or hi-rez digital stills.

**From flat fronts to touchable oil paintings - this is a new kind of movie magic.**

Computer/mobile screens are 72 dpi (dots/pixels per inch). Magazine ads are 300 dpi.

**Crosstown's film/tv printing** does up to an astounding ... **1400 dpi.**



# Set Dec and Props - Printing Revolutionized



*“But wait, there’s more ...”*



# 3 Dimensional Cuts of Anything

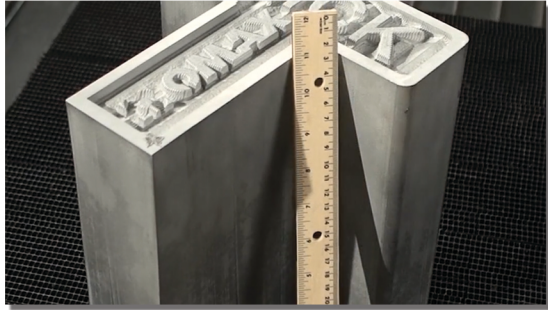

From *teeny-tiny* to “YUUUGE!”  
You can create miniscule jewelry, *f/x*  
*miniature set models*, along with amazingly intricate gobos for  
lighting.



*Or... go big.*

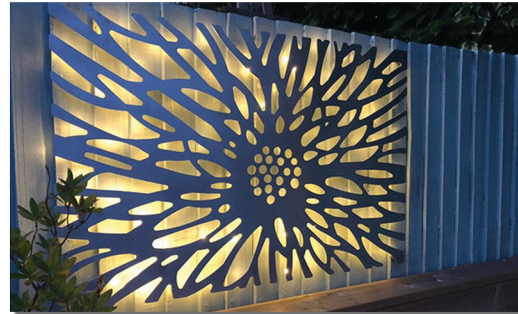
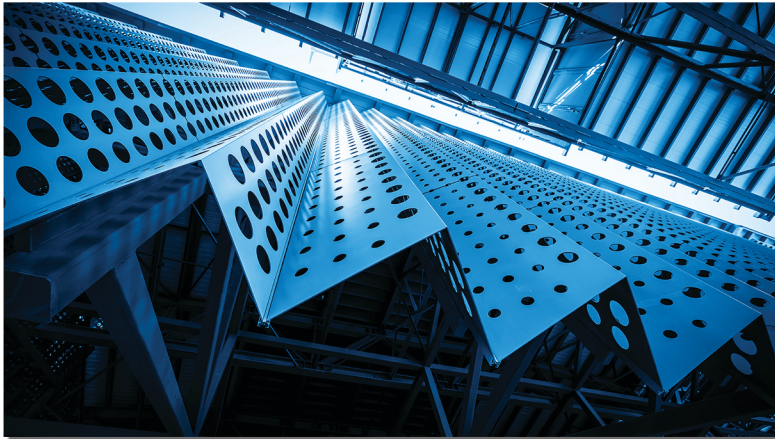

*More About 3D Cuts ...*



# Whatever You Envision - Get It 3D Cut!

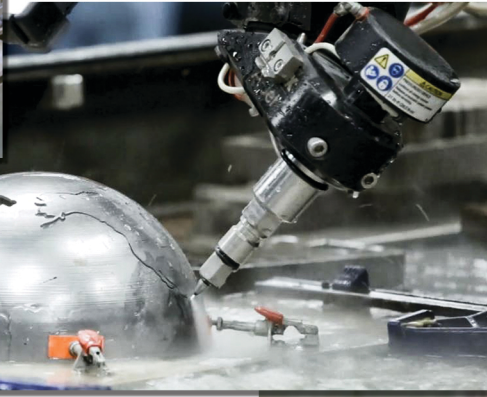
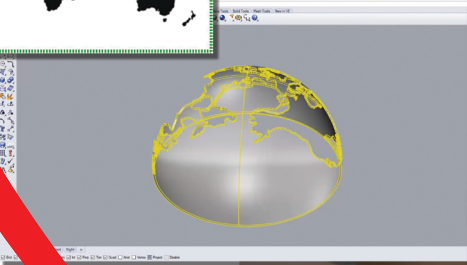

*NOTE: All photos are of actual 3D cuts from this 3D cutter.*



*Crosstown can 3D cut virtually any material for your set dec or prop needs. Up to 6.5 x 20 feet in width/length, spacious, with 5-axis cuts to 1-inch deep.*



“That’s a WRAP ... for now ...”

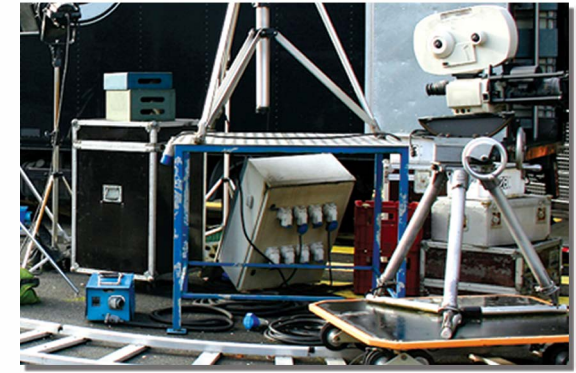

## Want a Crosstown 2.5D Printer Sample?

Contact Crosstown, then send in a hi-rez photo, graphic, or a copyright-cleared stock file - **CMYK, up to 1400 dpi** - no matter how large the file size. A very high resolution PDF, with any layers, or your master file (Photoshop, etc. ). For file transfer:  email: [film-tv@crosstownmetal.com](mailto:film-tv@crosstownmetal.com)

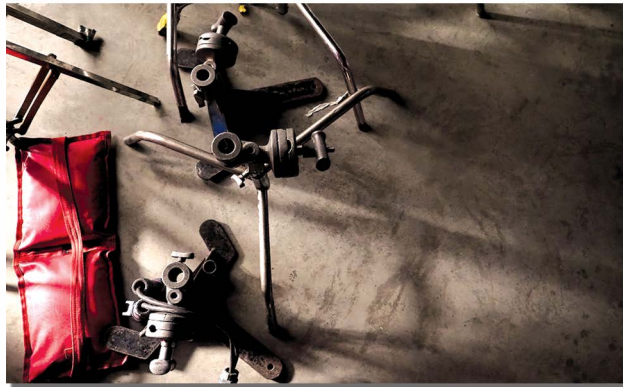

*Don't have a flat (wall - facade), set dec painting or prop photo?*  
Simply upload to Crosstown your hi-rez **film/tv company logo**.

*Note: Unless otherwise arranged, most samples are usually 1 x 1 feet in size.*

## What About 3D Cutter Samples?

Contact Crosstown to arrange possible 3D cutter samples.

*\*All samples, 2.5D print or 3D cuts, include a small Crosstown Industries trademarked logo.*

*From the Crosstown film/tv 'menu,' you can order à la carte or a complete seven-course dinner. Remember that with 2.5D printing and 3D cuts, Crosstown can also deliver in many forms. For instance, add key metal fixtures for 2.5D flat fronts, dress top of wide camera frames with HVAC venting, add practical steel - glass - wood to sets, or have full walls/high ceilings with custom architectural metal alloys.*

Stay Tuned...



 goto: [Crosstownmetal.com](http://Crosstownmetal.com)